

Mobile PA

Portable Audio System



User Manual





Table of Contents

OVERVIEW

- 3** Important Safety Instructions
- 5** System Components
- 6** Side Panel Controls
- 8** Flexmike Controls and Connections
- 9** Sharemike Controls and Connections
- 10** Connecting the Power Supply
- 11** Install the Carrying Strap

SET-UP & OPERATION

- 12** Setting Up the Flexmike
- 13** Pairing your Microphone
- 14** Set-Up Location
- 15** Companion Speaker
- 16** Voice Priority
- 17** Bluetooth Pairing to Personal Devices

OPTIONAL ACCESSORIES

- 18** Media Connector Set Up and Operation
- 19** Media Connector Controls and Indicators
- 21** Connecting Media Connector to Audio
- 22** Audio Integration with Media Connector
- 23** Pairing Mobile PA to Media Connector
- 24** Connect Mobile PA to an Existing Audio System
- 25** Adding Student Microphones to Mobile PA
- 26** Output to Assistive Listening Device (ALD)
- 27** Using Your Microphone as a Wireless Audio Link

MAINTENANCE & TROUBLESHOOTING

- 28** Microphone Battery Replacement
- 29** Battery Replacement
- 30** Troubleshooting

WARRANTY, SAFETY & SPECIFICATIONS

- 31** Five-Year Limited Warranty
- 32** Safety Warnings and Certifications
- 38** System Components
- 39** System Specifications



OVERVIEW

Important Safety Instructions

1. Do not use the apparatus near water.
2. Clean only with dry cloth.
3. Do not block any ventilation openings.
4. Do not install near any heat sources such as radiators, heat registers, stoves, or other apparatus (including amplifiers) that produce heat.
5. Do not defeat the safety purpose of the polarized or grounding-type plug. A polarized plug has two blades with one wider than the other. A grounding-type plug has two blades and a third grounding prong. The wide blade or the third prong is provided for your safety. If the provided plug does not fit into your outlet, consult an electrician for replacement of the outlet.
6. Protect the power cord from being walked on or pinched particularly at plugs, convenience receptacles, and the point where they exit from the apparatus.
7. Unplug this apparatus during lightning storms or when unused for long periods of time.
8. Refer all servicing to qualified service personnel. Servicing is required when the apparatus has been damaged in any way, such as power-supply cord or plug is damaged, liquid has been spilled or objects have fallen into the apparatus, the apparatus has been exposed to rain or moisture, does not operate normally, or has been dropped.
9. When the mains plug or appliance coupler is used as the disconnect device, it shall remain readily operable.
10. Please keep the unit in a good ventilation environment.
11. **WARNING:** To reduce the risk of fire or electric shock, do not expose this apparatus to rain or moisture.
12. Apparatus shall not be exposed to dripping or splashing and no objects filled with liquids, such as vases, shall be placed on the apparatus.
13. **WARNING:** Battery pack shall not be exposed to excessive heat such as sunshine, fire or the like. (1) The battery pack is not serviceable. Do not open, disassemble, or service any battery pack. (2) Do not crush or cut or puncture the internal battery cell. (3) Do not short-circuit the battery, or expose it to water or other liquids. (4) Do not touch the internal battery cell for any reason. (5) Keep the battery away from fire or a hot oven. Do not dispose of the battery into fire or a hot oven. (6) Keep the product with battery away from extremely low air pressure or high temperature surrounding environment. Battery subjected to extremely low air pressure may result in an explosion or the leakage of flammable liquid or gas. (7) Stop using the battery pack if it is damaged, or if you notice any discharge or the buildup of foreign materials on the battery contacts. (8) Do not put the battery in trash that is disposed of in landfills. When disposing of the battery pack, comply with local ordinances or regulations.
14. **CAUTION:** Risk of explosion if battery is replaced by any battery other than Lightspeed Part # L3.7V.
15. When connected to AC power, the equipment must be connected using the protective earthing (grounding) conductor to the AC wall socket (by means of a power cord connected to a socket-outlet with earthing/grounding connection).



OVERVIEW

Consignes de sécurité importantes

1. N'utilisez pas l'appareil près de l'eau.
2. Nettoyer uniquement avec un chiffon sec.
3. Ne bloquez aucune bouche d'aération.
4. Ne l'installez pas à proximité de sources de chaleur telles que des radiateurs, des registres de chaleur, des cuisinières ou d'autres appareils (y compris des amplificateurs) produisant de la chaleur.
5. N'annulez pas l'objectif de sécurité de la fiche polarisée ou de mise à la terre. Une fiche polarisée a deux lames dont l'une est plus large que l'autre. Une fiche de type mise à la terre a deux lames et une troisième broche de mise à la terre. La lame large ou la troisième dent est prévue pour votre sécurité. Si la fiche fournie ne rentre pas dans votre prise, consultez un électricien pour remplacer la prise.
6. Protégez le cordon d'alimentation contre les piétinements ou les pincements, en particulier au niveau des fiches, des prises de courant et du point de sortie de l'appareil.
7. Débranchez cet appareil pendant les orages ou lorsqu'il n'est pas utilisé pendant de longues périodes.
8. Confiez toutes les réparations à un personnel de service qualifié. Une réparation est nécessaire lorsque l'appareil a été endommagé de quelque manière que ce soit, comme le cordon d'alimentation ou la fiche est endommagé, du liquide a été renversé ou des objets sont tombés dans l'appareil, l'appareil a été exposé à la pluie ou à l'humidité, ne fonctionne pas normalement, ou a été supprimé.
9. Lorsque la fiche secteur ou le coupleur de l'appareil est utilisé comme dispositif de déconnexion, il doit rester facilement utilisable.
10. Veuillez conserver l'appareil dans un environnement bien aéré.
11. Avertissement: Pour réduire le risque d'incendie ou de choc électrique, n'exposez pas cet appareil à la pluie ou à l'humidité.
12. L'appareil ne doit pas être exposé aux gouttes ou aux éclaboussures et aucun objet rempli de liquide, tel que des vases, ne doit être placé sur l'appareil.
13. Avertissement: La batterie ne doit pas être exposée à une chaleur excessive telle que le soleil, le feu ou similaire. (1) La batterie n'est pas réparable. N'ouvrez, ne démontez et n'entretenez aucun bloc-piles. (2) Ne pas écraser, couper ou percer la cellule de batterie interne. (3) Ne court-circuitez pas la batterie et ne l'exposez pas à l'eau ou à d'autres liquides. (4) Ne touchez pas la cellule de la batterie interne pour quelque raison que ce soit. (5) Gardez la batterie à l'écart du feu ou d'un four chaud. Ne jetez pas la batterie au feu ou dans un four chaud. (6) Gardez le produit avec la batterie à l'écart d'une pression d'air extrêmement basse ou d'un environnement à haute température. Une batterie soumise à une pression d'air extrêmement faible peut provoquer une explosion ou une fuite de liquide ou de gaz inflammable. (7) Arrêtez d'utiliser la batterie si elle est endommagée ou si vous remarquez une décharge ou l'accumulation de corps étrangers sur les contacts de la batterie. (8) Ne jetez pas la batterie dans des ordures qui sont jetées dans des décharges. Lors de la mise au rebut de la batterie, respectez les ordonnances ou réglementations locales.
14. Mise en garde: Risque d'explosion si la batterie est remplacée par une batterie autre que Lightspeed partie #L3.7V.
15. Lorsqu'il est connecté à l'alimentation secteur, l'équipement doit être connecté à l'aide du conducteur de mise à la terre de protection à la prise murale CA (au moyen d'un cordon d'alimentation connecté à une prise de courant avec connexion de mise à la terre).



OVERVIEW

System Components

The standard configuration of Mobile PA includes:

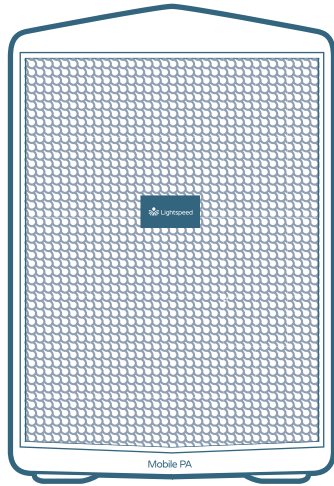

Mobile PA

Receiver/Amplifier and Power Supply



Flexmike

Classroom Microphone



Sharemike

Handheld Microphone (optional)

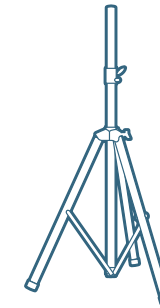

Mounting Tripod

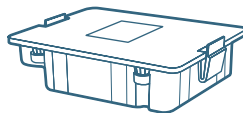

Battery Pack

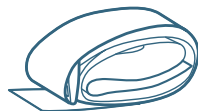

Carry Strap

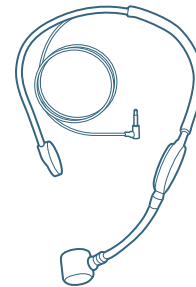

Headset Mic

for Flexmike



Media Connector



To reduce potential safety issues, only the power supply (part# 24V-2.5A-NA) and battery pack (part# L14V) provided by Lightspeed Technologies should be used with Mobile PA.



Side Panel Controls

1. **IR RECEIVER:** For pairing to microphones

STATUS LIGHT: Microphone link and pair indicators

Solid blue: Audio link has been established

Solid white: Companion speaker paired

Alternating blue/white: Pairing in process

Off: Unpaired or nothing linked

2. **BATTERY LIGHT**

Solid red: Indicates charge in progress

Blinking red: Indicates low battery

Solid green: Charge is complete

3. **POWER LIGHT**

Solid white: Indicates power on

4. **POWER ON/LEVELS CONTROL:** Controls volume and tone levels from the selectors below.

5. **AUDIO OUTPUT VOLUME SELECTOR:** Press to show audio output volume level, use level control to adjust.

6. **AUDIO INPUT VOLUME SELECTOR/BLUETOOTH PAIRING:**

Press to show audio input volume level, use level control to adjust.

Press and hold to initiate Bluetooth pairing to other devices such as smartphones.

7. **TONE CONTROL SELECTOR:**

Press to show tone level, use level control to turn bass up or down.

Press and hold to for pairing to other Lightspeed devices such as Media Connector or Mobile PA companion speaker.

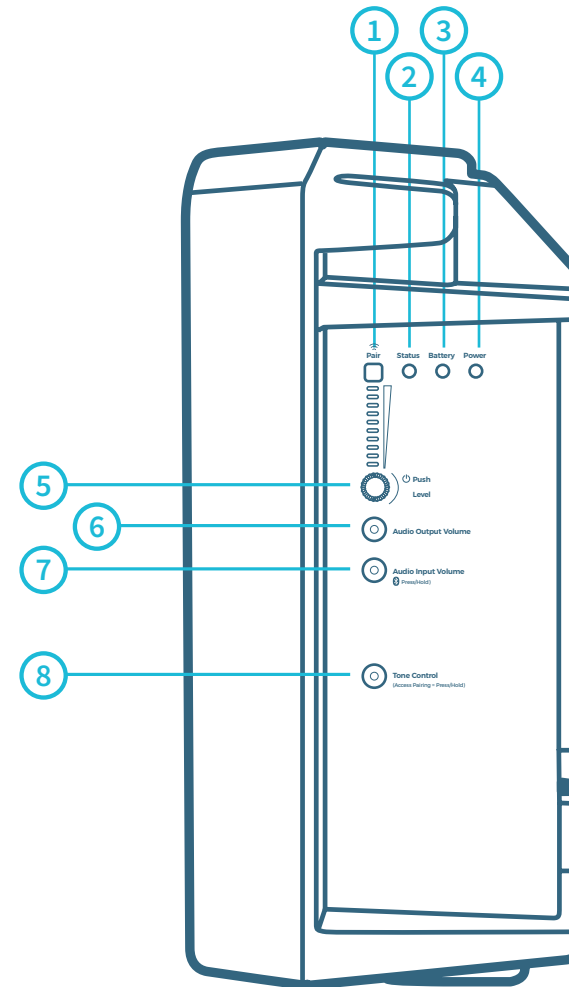



Back Panel Controls and Connections

1. **VOICE PRIORITY SWITCH:** Voice priority will fully mute auxiliary audio sources when speaking into the microphone.
 - Switch in top position indicates Voice priority is ON
 - Switch in bottom position indicates Voice priority is OFF
2. **MODE SWITCH:** A second Mobile PA can operate as a companion speaker when switch is in the top position.
3. **AUDIO OUTPUT JACK:** 3.5mm stereo connector for connecting to an assisted listening device (ALD) or to a computer for recording.
4. **AUDIO INPUT JACK:** 3.5mm stereo connector for connecting to a computer or mobile device as an audio source.
5. **POWER JACK:** Plug the power supply (24V/2.5A) into this jack to power and charge the unit.
6. **CARRY STRAP SLOTS**
7. **CARRYING HANDLE**
8. **INTEGRATED MICROPHONE CHARGERS**
9. **COMPARTMENT FOR BATTERY PACK**

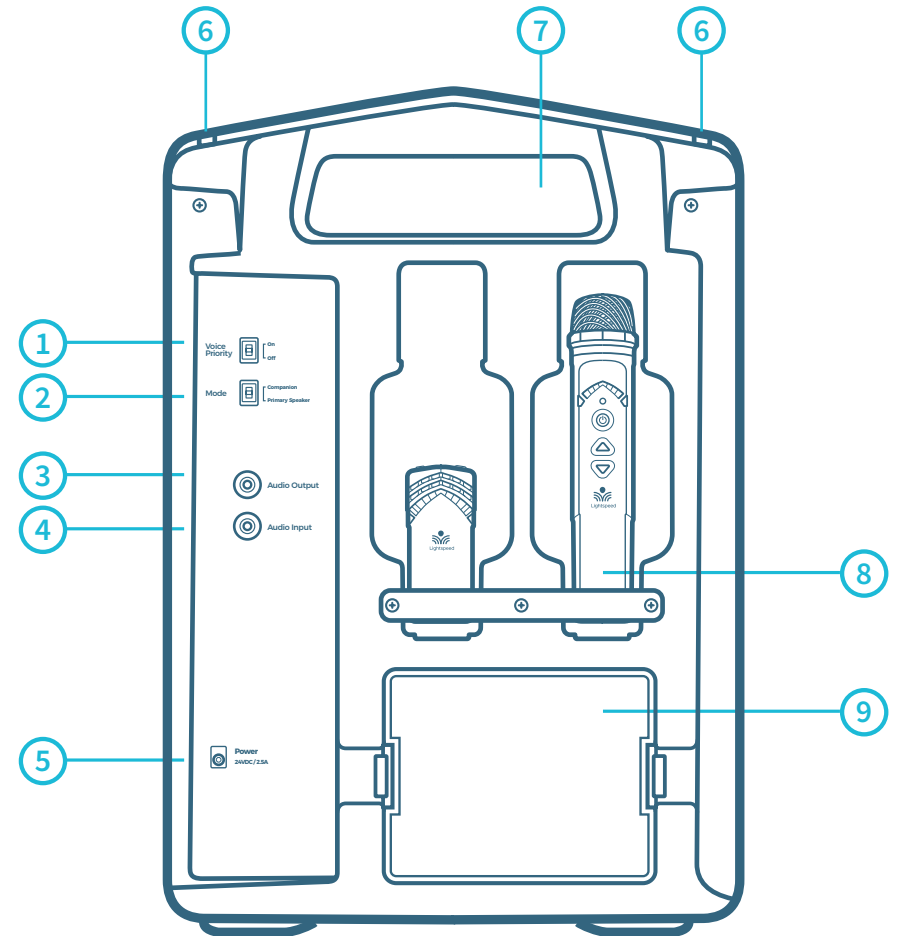



Flexmike Controls and Connections

- POWER/MUTE SWITCH:** Press and hold for 1 second to power on, press to mute or talk, press and hold to power off.
Blue light: Talk
White light: Mute
- IR TRANSMITTER:** For pairing to base unit.
- MIC 1 STATUS:** lighted to indicate microphone is registered as Mic 1
White: solid = Normal operation
White: flashing = Pairing in progress
- MIC 2 STATUS:** When using a second microphone, this LED is lighted to indicate microphone is registered as Mic 2
White: solid = Normal operation
White: flashing = Pairing in progress
- MICROPHONE VOLUME UP/DOWN**
- POWER STATUS LIGHT**
Red light: In operation, turns red to indicate low battery
White light: Normal operation

When charging in Cradle Charger:
Red light: Charging
Green light: Charging complete
- HEADSET/MIC CONNECTION:** Connect the headset microphone.
- LANYARD INTERFACE:** Insert the lanyard into this hook to wear the Flexmike.
- BATTERY:** Rechargeable battery pack is field replaceable.
- USB INPUT:** Connect to a personal computer for two-way audio and software updates to send to Mobile PA. USB input can also be used for charging.

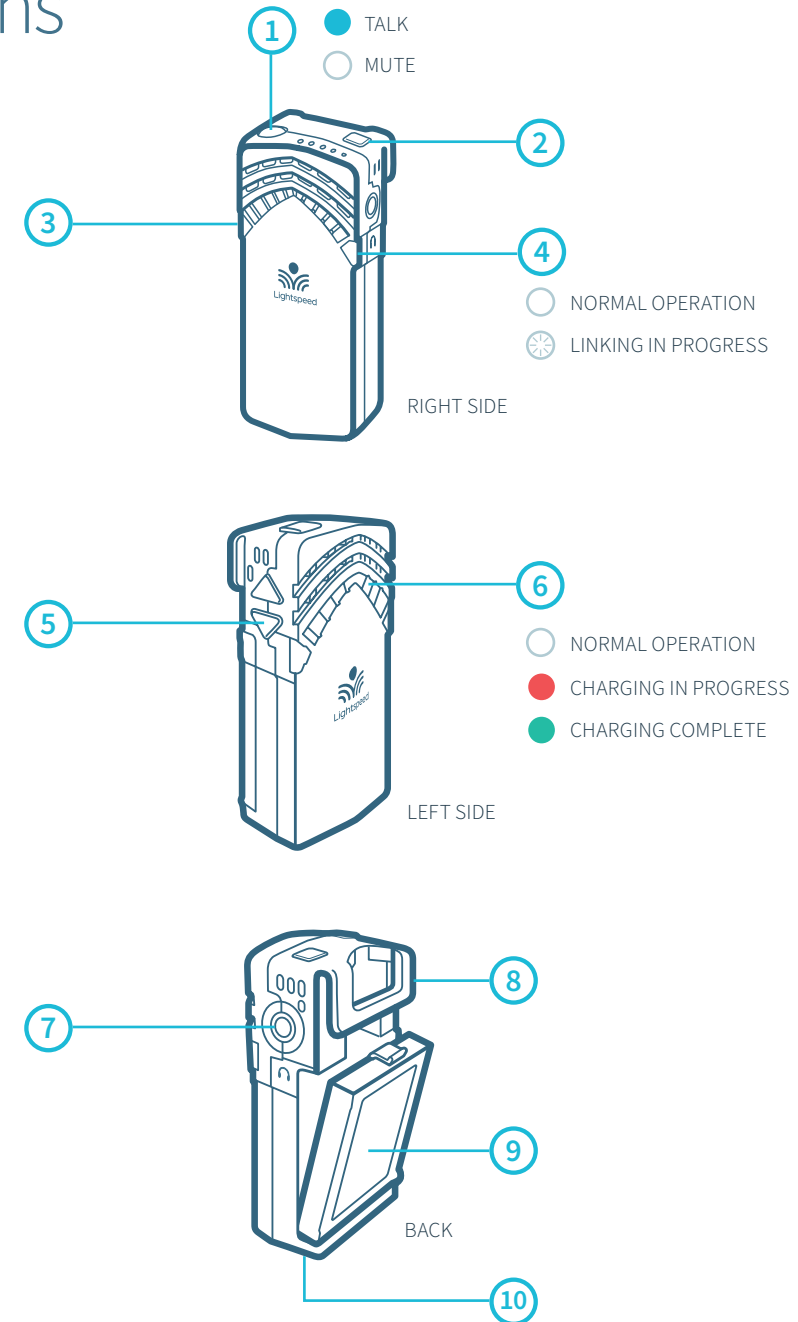



ShareMike Controls and Connections

1. POWER BUTTON

2. POWER STATUS LIGHT

Red light: During operation, turns red to indicate low battery

White light: Normal operation

When charging in Cradle Charger:

Red light: Charging

Green light: Charging complete

3. MIC 1 STATUS:

Lighted to indicate microphone is registered as Mic 1

White: solid = Normal operation

White: flashing = Pairing in process

4. MIC 2 STATUS:

Lighted to indicate microphone is registered as Mic 2

White: solid = Normal operation

White: flashing = Pairing in process

5. MUTE/TALK STATUS LIGHT

Blue: solid = Talk

White: solid = Mute

6. MICROPHONE VOLUME UP/DOWN

7. USB INPUT:

Connect to a personal computer for two-way audio and software updates to send to Mobile PA. USB input can also be used for charging.

8. IR TRANSMITTER:

For pairing to base unit

9. AUDIO INPUT:

Plug a laptop or other audio device into this jack to wirelessly transmit the audio signal to be played through the system.

10. VOLUME LOCK:

Disables volume controls.

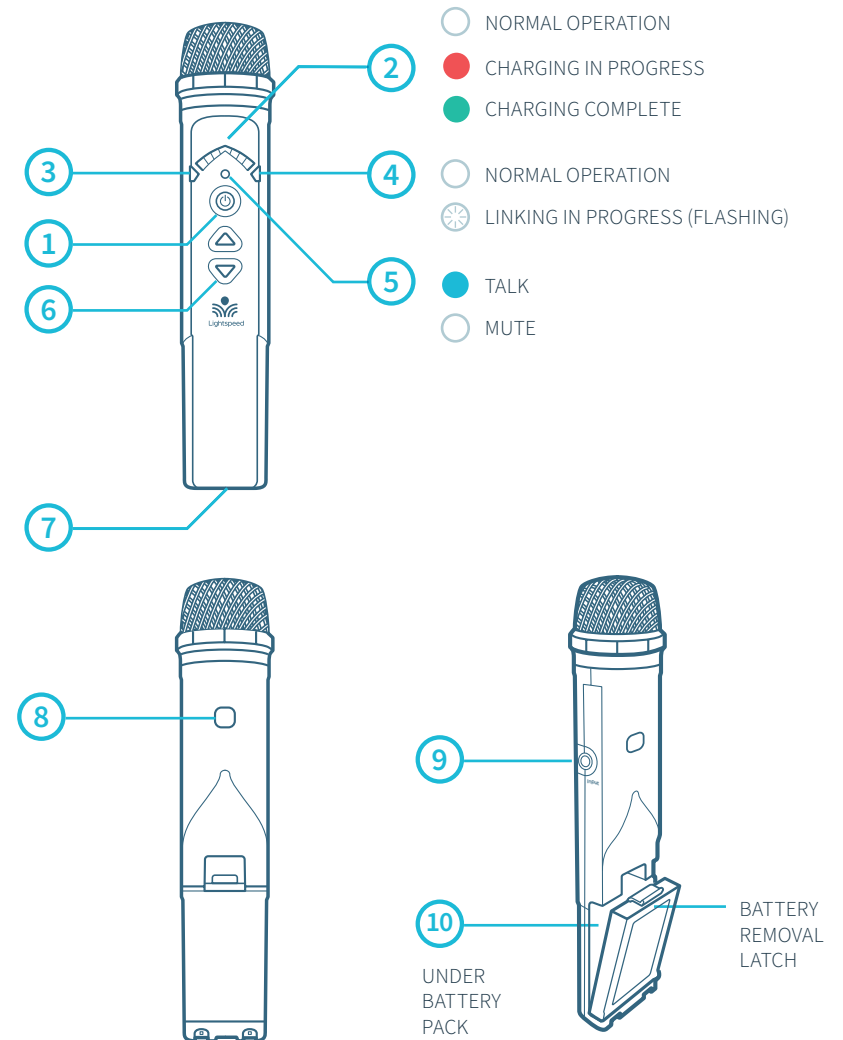



Connecting the Power Supply

- Locate the power supply and AC power cord and connect it to the DC power supply.
- Insert the DC connector into the jack labeled “Power” on Mobile PA. Plug the AC power cord to an electrical outlet.
- Mobile PA automatically powers on and the white Power light on the side panel will appear.
- When connected to power, Mobile PA will operate as normal while the battery is charging. It takes approximately 4-5 hours to fully charge the battery.
- When Mobile PA is powered by the battery pack only, it will operate for a full 8 hour day.
- **NOTE:** To help maintain battery life while not in use, press the power control button. The white power status light will turn off to indicated complete shut off.

CHARGE MICROPHONES NIGHTLY

- Place the microphones into the integrated cradle charger. The power status light will glow red when it is charging.
- When charging is complete, the power status light will glow green.
- Mics take 5-6 hours to charge and will operate for a full 8 hour day.

NOTE: Microphones will only charge when Mobile PA is plugged into AC power.

- NORMAL OPERATION
- CHARGING IN PROGRESS
- CHARGING COMPLETE

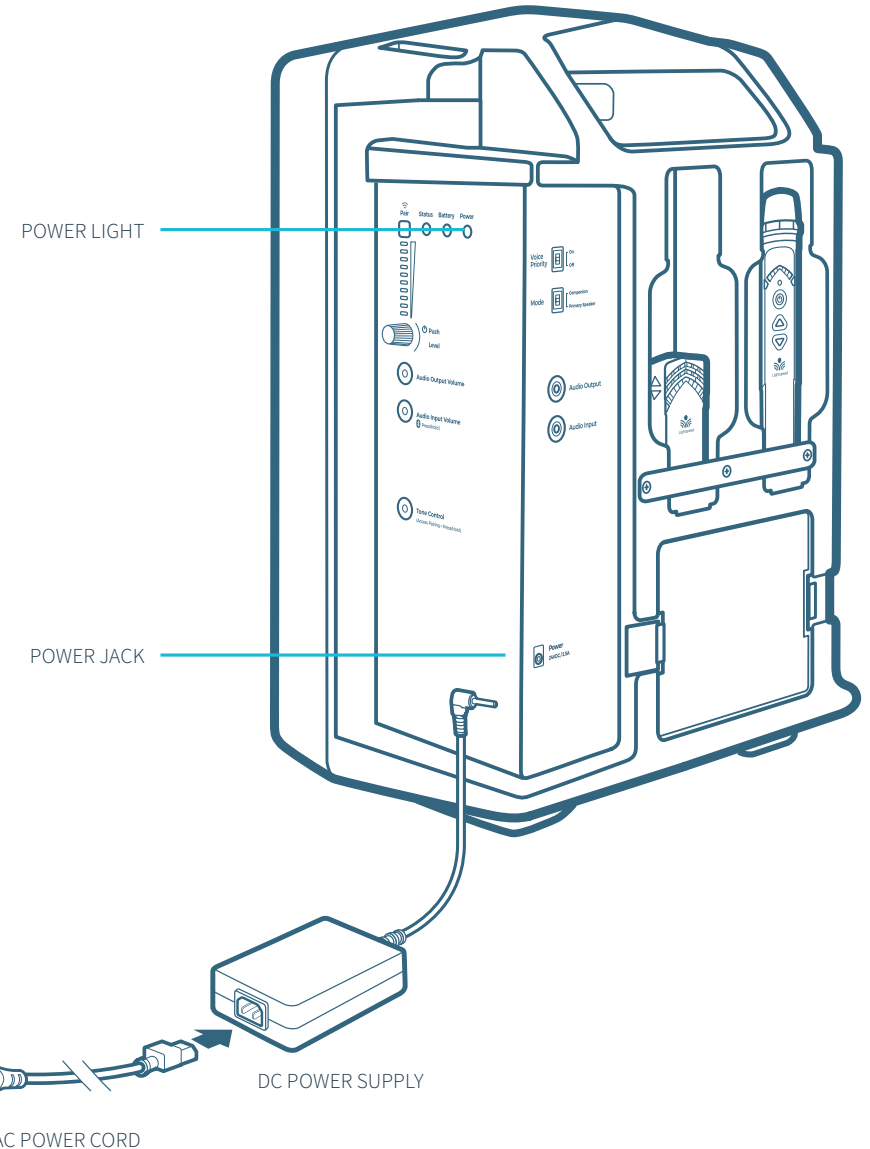
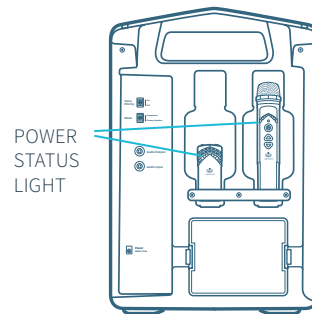

To reduce potential safety issues, only the power supply (part# 24V-2.5A-NA) provided by Lightspeed Technologies should be used with Mobile PA.



Install the Carrying Strap

- Locate the carrying strap and insert both ends into the strap slots on top of the Mobile PA.
- Press together the velcro section firmly to secure the strap.

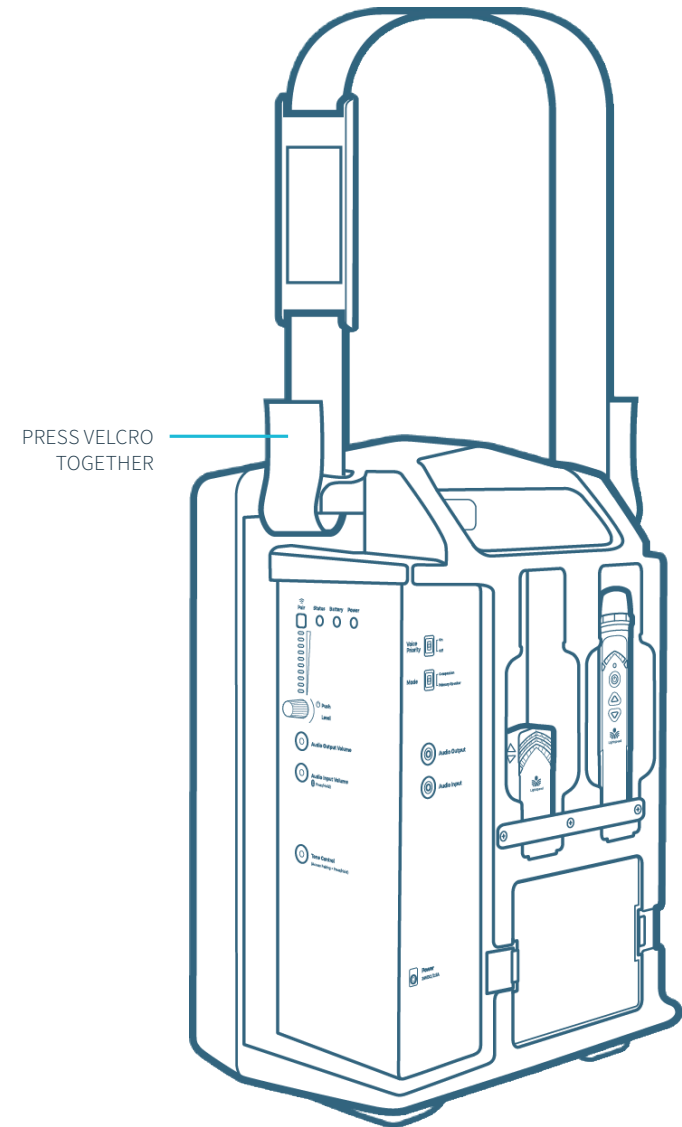
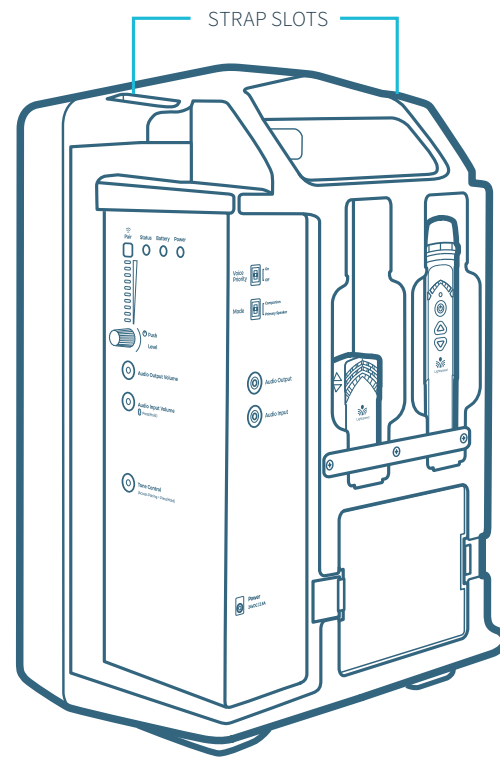



SET-UP & OPERATION

Setting Up the Flexmike

Once the Flexmike is charged, follow these steps for use.

1. Remove the Flexmike from the charger and put it on by connecting the magnetic clasps behind your neck. Adjust the lanyard so that the top of the Flexmike aligns with the collarbone.
2. The Flexmike will automatically power on and mute when it is removed from the charger.
3. The microphone volume on the Flexmike is set at the factory to the midpoint. It is adjusted by the up/ down buttons on the side of the microphone when the microphone is not muted.
4. While speaking in a normal voice, fine tune the microphone volume. Proper volume level should be as follows:
 - Your voice should be clearly heard by another person on the other side of the room.
 - You should barely be able to hear your own voice.
 - There should not be any audio “feedback” or squealing outside of 2-3 feet (if there is, turn the volume down slightly).

REMEMBER: This equipment supplements the user’s voice so they are able to speak in a conversational tone. Having the volume set too high will result in feedback and listener fatigue.

- Once initial volume level is set, walk around the room and listen for overall audio quality.
- If further fine tuning is required, you may need to adjust the Tone Control on the side of the Mobile PA.
- If the Flexmike is out of range, it will automatically shut off after 30 minutes of trying to reconnect. Once you are back in range, simply press and hold the power button for 1 second on the Flexmike to power it up and resume normal operation.

NOTE:

The headset microphone is recommended in spaces with loud ambient noise.

ALIGN WITH
COLLARBONE

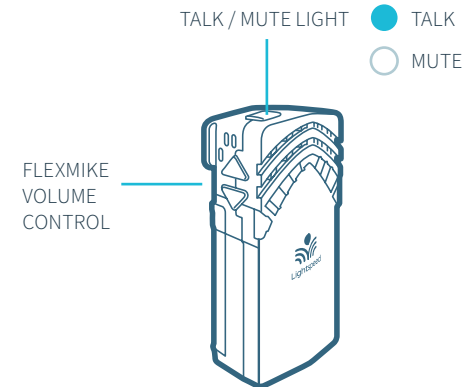
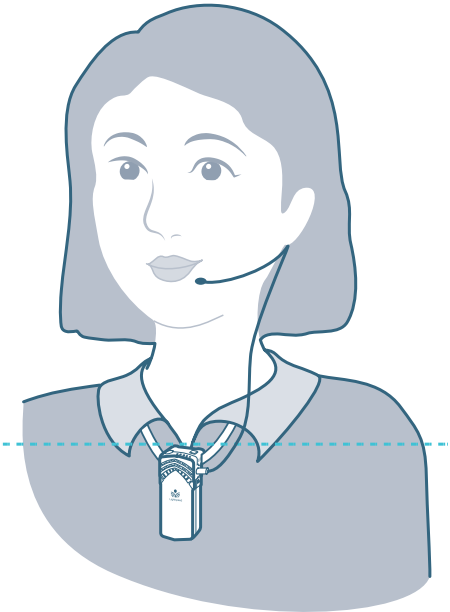



Pairing your Microphone

 Your system is shipped with microphones and Mobile PA paired for quick and easy use. If you need to pair new components, follow this pairing process:

1 From a powered off state, point the IR transmitter lens toward Mobile PA (for ShareMike, the transmitter lens is located on the back of the microphone).

2 Press and hold the power button for 5 seconds until the mic 1 and mic 2 lights start flashing, then release the button and let the pairing process finish. Status light on Mobile PA will flash blue/white in pairing mode.

3 The status light on Mobile PA will glow blue indicating the pairing process is complete. The Mic 1 or Mic 2 light on the microphone will stay illuminated.

FLEXMIKE

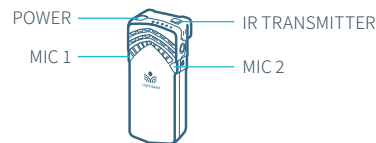
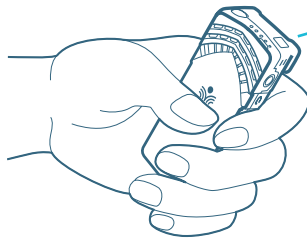

IR RECEIVER

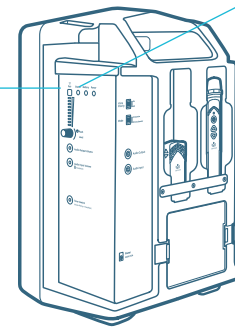

MOBILE PA

STATUS LIGHT

-  BLINKING BLUE/WHITE: PAIRING MODE
-  SOLID BLUE: PAIRING COMPLETE

SHAREMIKE

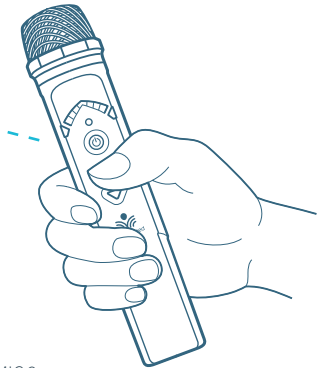

IR TRANSMITTER



BACK

MIC 1 MIC 2

POWER



FRONT



Set-Up Location

FOR INDOOR USE

- Find a location where the Mobile PA is facing the audience.
- If this is not possible, other good locations are along either wall next to the presenter or in a corner.
- Avoid placing Mobile PA behind or right next to where the person speaking. Putting Mobile PA in close proximity to the speaker's microphone can result in feedback.
- For quick setup and portability, place Mobile PA on a tabletop.
- Elevate on a tripod to broadcast in a larger space.

CAUTION: When using a tripod, legs must be fully extended for safety.

FOR OUTDOOR USE

When used outdoors, Mobile PA should be protected from rain and other water exposure.

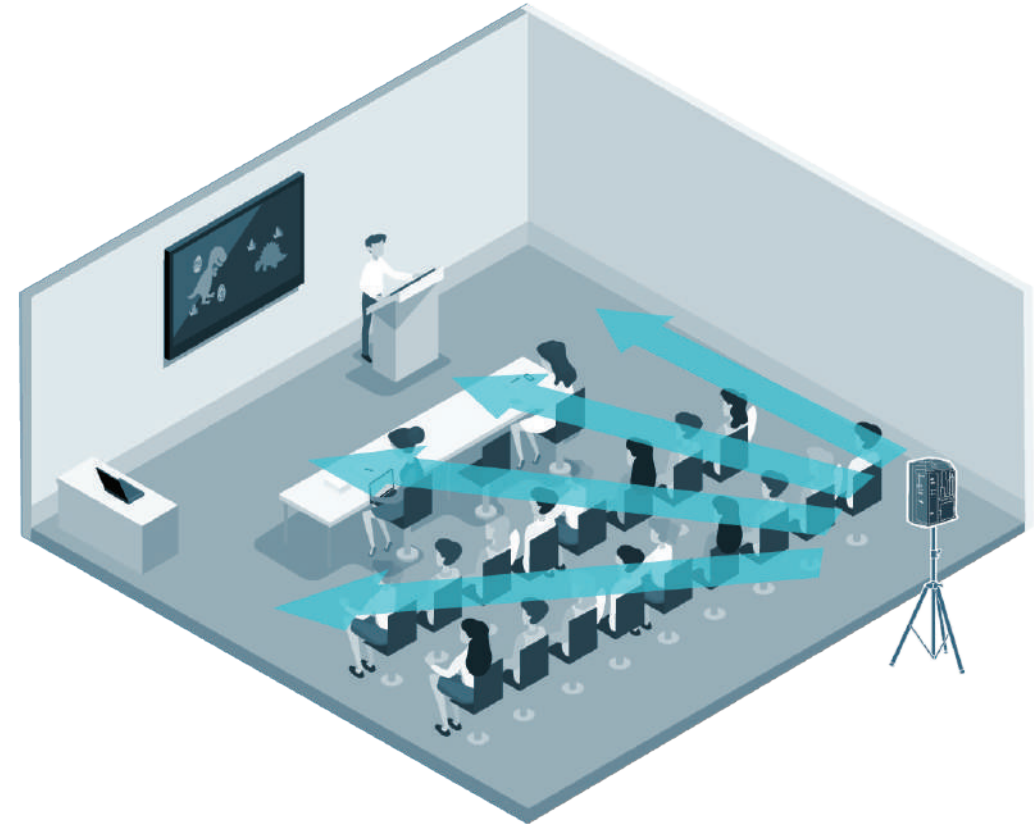

Coverage area indoor is up to 1,600 square feet and up to 1,150 square feet outdoor.



Companion Speaker

For larger spaces, Mobile PA can operate as a 'companion' speaker to expand your coverage area up to 2,750 square feet indoor and up to 2,000 square feet outdoor. This is simply a second Mobile PA that has been switched into companion mode.

The Mobile PA in companion mode reproduces what is heard from the primary MPA speaker. Audio inputs of the companion speaker are heard through both the primary and companion speakers.

SET UP A COMPANION SPEAKER

1. To set up a second Mobile PA as a companion speaker, slide the mode switch up to companion mode on the back of the Mobile PA.
2. Press/hold the Tone button for 5 seconds on companion speaker to place it in pairing mode. The status light will begin blinking.
3. Then Press/ Tone button for 5 seconds on the primary speaker to place it in pairing mode as well. The status light will begin blinking.
4. After several seconds, the two speakers will connect and the status light on the primary speaker will turn solid blue and solid white on the companion speaker.

Please note the position of the companion mode switch:

- The bottom position of the switch is Mobile PA primary mode.
- The top position of the switch is Mobile PA companion mode.

Audio input volume, audio output volume, and tone of the overall system can be adjusted from either the primary or companion Mobile PA. The volume of the companion speaker mirrors the volume level on the primary Mobile PA and cannot be adjusted independently.

NOTES ON PAIRING

- If a companion speaker was already paired to the primary Mobile PA, it will reconnect without the need to pair again. However, if the Mobile PA has been paired to another Mobile PA as a companion speaker or a Media Connector, it will be necessary to pair again.
- Only microphones paired to the primary Mobile PA will be in use. Microphones cannot be paired to the companion unit.
- User can pair Bluetooth to both primary and companion Mobile PA.
- Pairing will be indicated when the status light on both units blink blue/white.
- Media Connector (for wireless media) cannot be connected when companion speaker is in use.

PLACEMENT

Companion speaker should be placed within 150 ft of the primary speaker.



COMPANION SPEAKER

COMPANION MODE SWITCH

TONE CONTROL SELECTOR

PRIMARY SPEAKER

STATUS LIGHT

TONE CONTROL SELECTOR

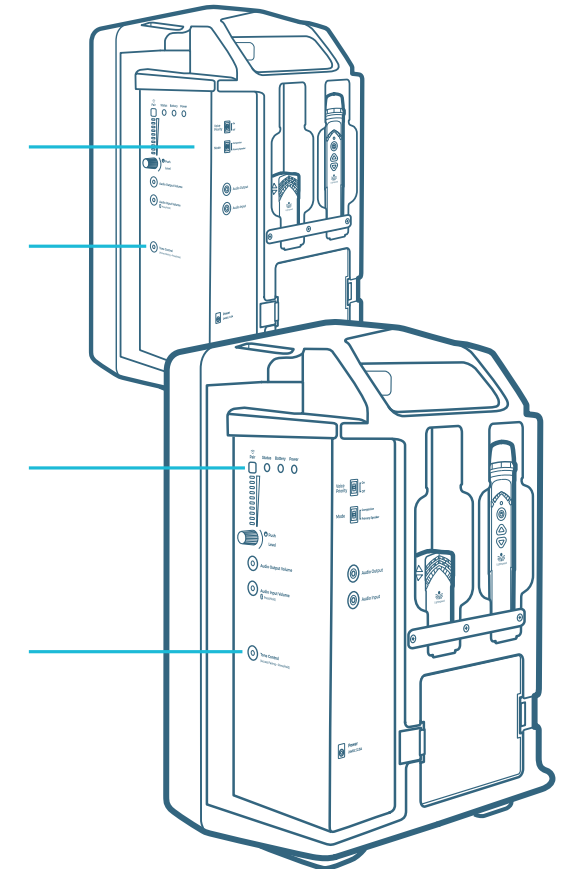



Voice Priority

Voice priority is a feature that fully mutes auxiliary audio sources when the user is speaking into the microphone. This function is activated by a hardware slide switch on the back of the Mobile PA.

TO USE THIS FEATURE

- To turn Voice Priority ON, slide switch up.
- To turn Voice Priority OFF, slide switch down.
- On your microphone, quick press on the power button to unmute.
- After Voice Priority has been triggered, it will stay active until all microphones paired to the Mobile PA are muted. Once all microphones are muted, the system will immediately return to normal audio operation.

NOTE: Voice priority does not pause the audio source, it only mutes it.

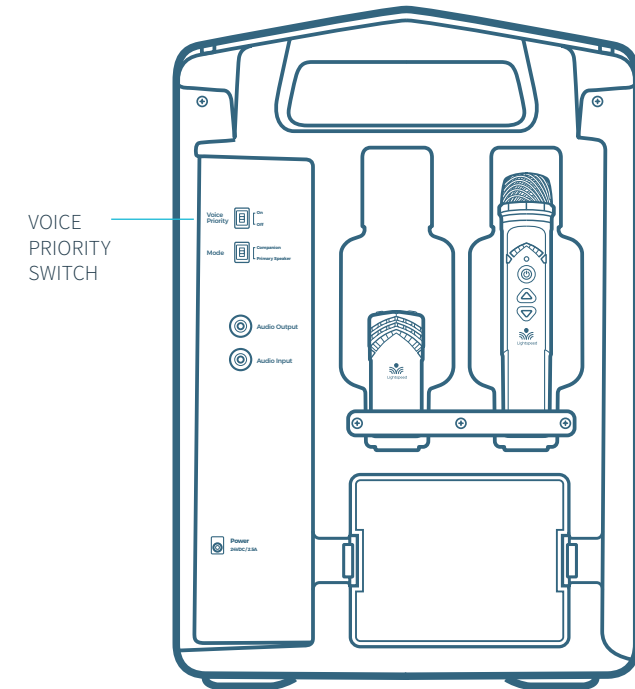

POWER/MUTE BUTTON ● UNMUTE

○ MUTE





Bluetooth Pairing to Personal Devices

PAIRING PERSONAL DEVICE TO MOBILE PA BLUETOOTH

1. On a personal device or laptop, make sure your Bluetooth setting is on and in the search mode.
2. Press and hold the Audio In button for 3-5 seconds.
3. Once Bluetooth pairing is activated, the Status Light will begin flashing (blue/off).
4. On your mobile device, select "Lightspeed MPA" in your bluetooth settings to connect to Mobile PA
5. When pairing is complete, the Status Light will return to solid blue.
6. Once in pairing mode, the Bluetooth device name should advertise to your mobile device or computer as "Lightspeed MPA" (Note: Bluetooth will NOT advertise unless it is in pairing mode). Bluetooth in companion mode will use the same name.
7. Each Mobile PA will remember two Bluetooth mobile devices, and when more mobile devices are paired, the previously stored mobile device will be cleared.

Bluetooth pairing is available for both the primary and companion Mobile PA.

PAIR TO:
"Lightspeed MPA"

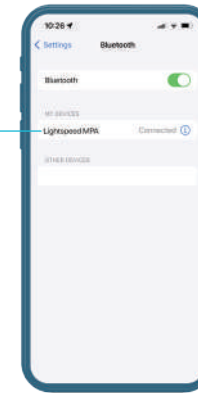

STATUS LIGHT  BLINKS BLUE IN PAIRING MODE, SOLID BLUE WHEN PAIRING IS COMPLETE

PRESS AND HOLD
AUDIO INPUT
SELECTOR
BUTTON FOR
3-5 SECONDS

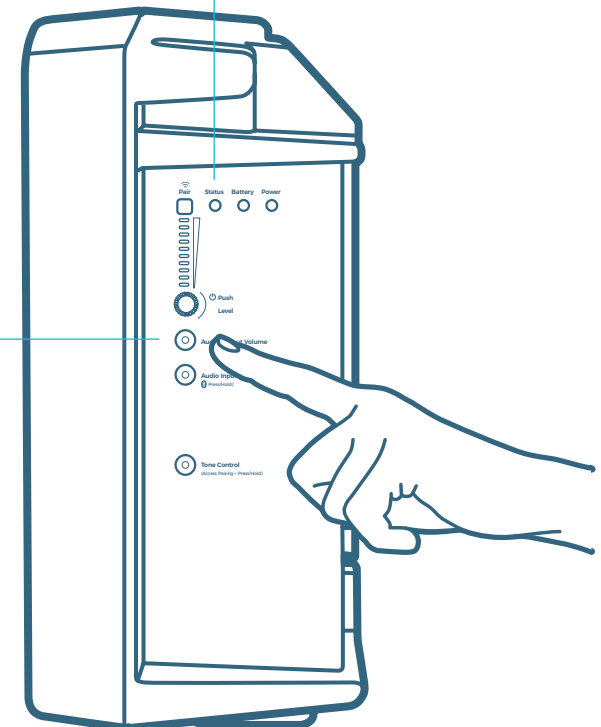



OPTIONAL ACCESSORIES

Media Connector Set Up and Operation

DETERMINE LOCATION

Media Connector is designed to be connected to the primary media source in the learning space, usually the computer or display panel.

WALL MOUNT OR DESKTOP

- Choose a location that is convenient to the classroom audio sources and power supply.
- It should be located 3-6 feet off of the floor to allow for good transmission.
- Do not enclose in a metal cabinet or in a location where the signal will be obstructed.

NOTE: The Media Connector does not require a direct line of sight to Mobile PA. However it functions best when no obstructions are between the two devices.

The Media Connector can be placed on a table surface or wall-mounted.

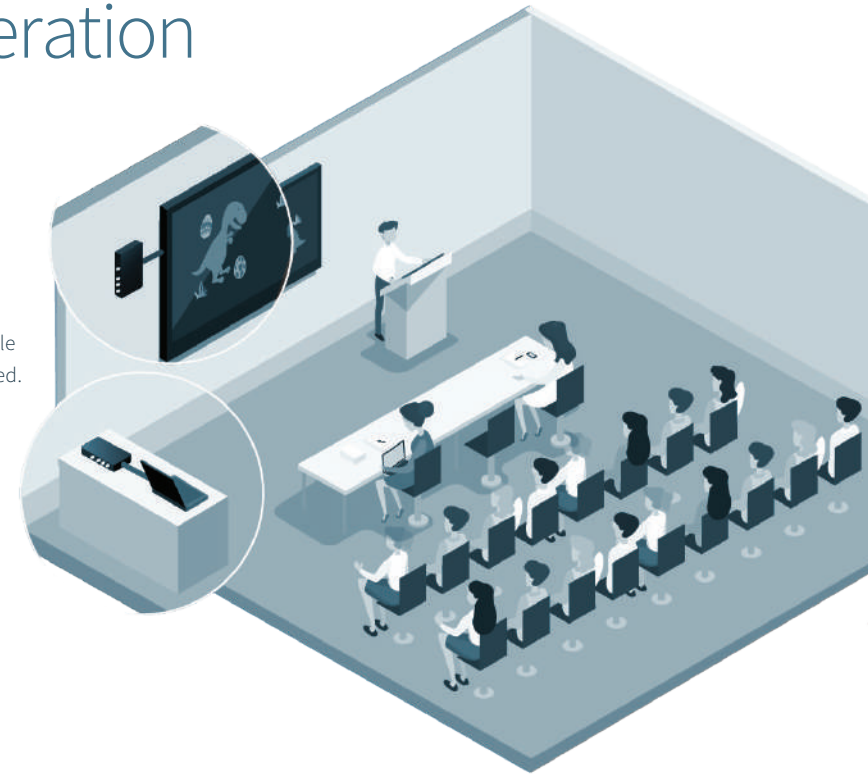

CONNECT TO POWER

Connect the USB power cord to a computer. Plug the USB cable into the USB input on the back of the Media Connector. By default, connecting the Media Connector USB to the computer disables the 3.5mm audio inputs and outputs and switches over to the USB audio of the computer.

or

Use the USB power adapter to plug into a wall outlet.

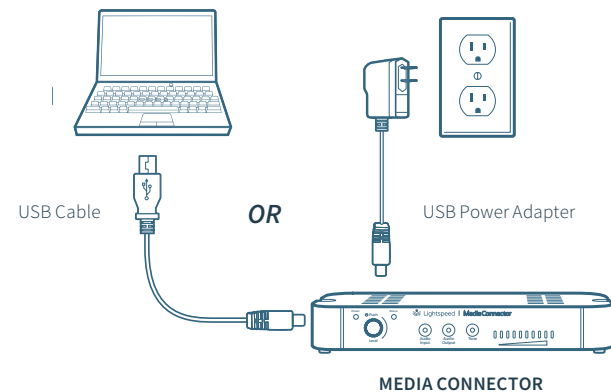



Media Connector Controls and Indicators

FRONT PANEL

- POWER LIGHT**
White light: Power on
- POWER BUTTON / VOLUME ADJUSTMENT:** Press this button to turn the system power on or off. This also functions as an adjustment knob for the volume and tone depending on the mode selected (see 4, 5, 6 below).
- STATUS LIGHT:** Base unit link and pair indicators.
Solid white: Mobile PA is paired to the system
Alternating blue/white: Pairing in process
Off: Mobile PA is not paired to the system
- AUDIO INPUT VOLUME SELECTOR:** Press the Audio In button and turn the adjustment knob (2) to change the level of audio sources connected to the audio input on the back of the Media Connector.
- AUDIO OUTPUT VOLUME SELECTOR:** Press the Audio Out button and then turn the adjustment knob (2) to change the level of audio sources connected to the audio output on the back of the Media Connector.
- TONE SELECTOR:** Tone adjustment affects audio heard from the speaker. This adjusts the bass or treble that is heard through the Mobile PA speaker.

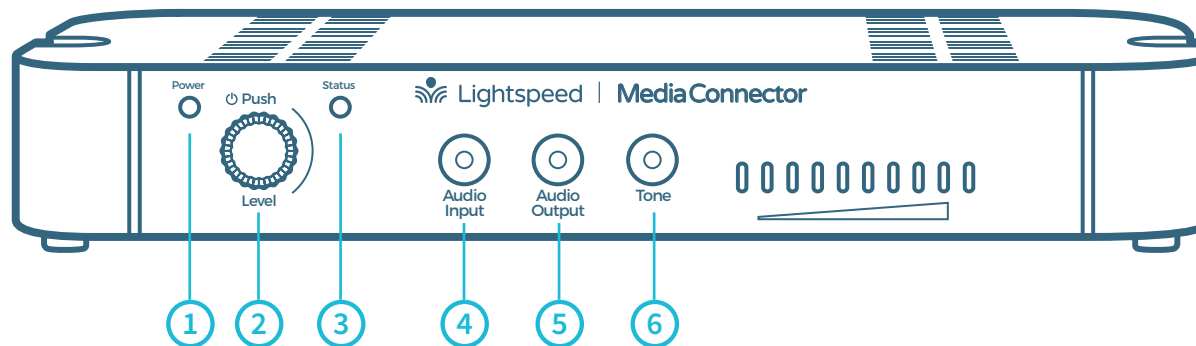



Media Connector Controls and Indicators

BACK PANEL

1. **AUDIO INPUTS:** 3.5mm stereo connectors for connecting classroom audio sources to be played through audio system.
2. **AUDIO OUTPUTS:** 3.5mm stereo connectors for connecting to an assisted listening device (ALD) or to a computer for recording.
3. **USB INPUT:** Plug the USB-C end of the power cable into this USB port on the Media Connector.
 - The USB port supplies power to the Media Connector when connected to the Media Connector power supply or from a laptop.
 - It also acts as a digital audio when connected to an audio source. Note that when the USB is used, the other four audio inputs and two audio outputs are not operational.

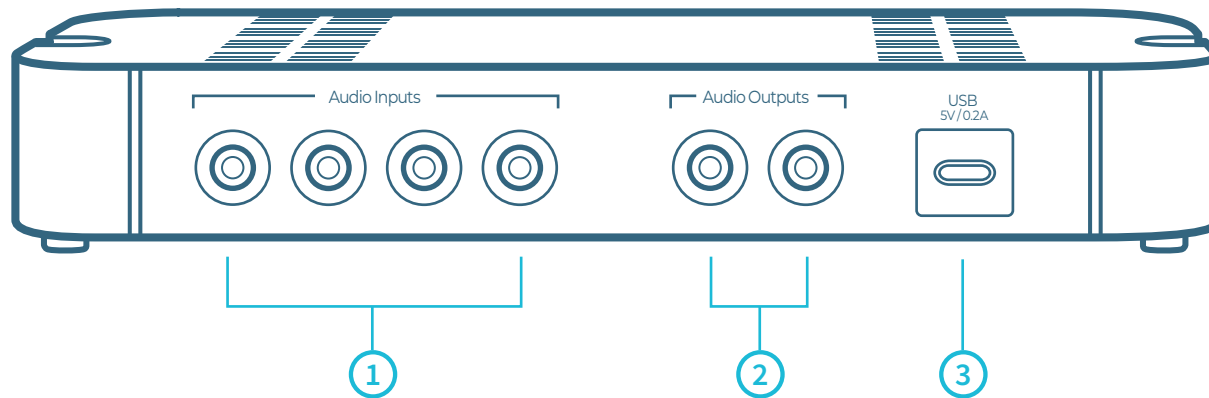



Connecting Media Connector to Audio

Audio can be connected using either digital 2-way USB audio or analog audio.

USB AUDIO

If locating and connecting to computer USB, Media Connector will default to digital USB audio (3.5mm analog audio ports will be disabled). USB audio enables a 2-way audio link to:

Send audio from the computer to MPA to ensure all audio can be played through the MPA speaker.

Send audio to the computer from MPA to ensure the teacher's Flexmike and any student microphones are clearly picked up by a video conferencing solution.

DISABLE/ENABLE USB AUDIO

To disable USB Audio and use computer USB for power only

- Unplug USB cable from Media Connector
- Press and hold Audio Out button
- Plug USB cable back to Media Connector
- Status light turns white to indicate USB audio is disabled
- Release Audio Out button and system will reboot with disabled USB audio
- Analog Audio Inputs are now active

To enable USB Audio on your Media Connector

- Unplug USB cable from Media Connector
- Press and hold Audio Out button
- Plug USB cable back to Media Connector
- Status light turns blue to indicate USB audio is enabled
- Release Audio Out button and system will reboot with enabled USB audio
- Analog Audio Inputs and Outputs are now inactive

ANALOG AUDIO

Plug your external audio equipment (e.g., video display) into one of the Audio input jacks.

Adjust the volume as needed by pressing the Audio Input selector and adjusting the level knob as needed.

COMPUTER SETTINGS

Once connected, open computer sound setting to select "Lightspeed Audio" as the microphone and speaker.

SETTING THE VOLUME LEVELS

For recording, or to interface with an Assistive Listening Device, connect a 3.5mm cable to the Audio Output of the Media Connector to the microphone input on the device. Press the button for the desired level adjustment.

- To adjust the Audio Input/Output volume of the speaker, press Audio Input or Output button and use the adjustment knob.
- To adjust the Tone (bass/treble) of the speaker, press Tone and use the adjustment knob to turn the bass up and down

BACK

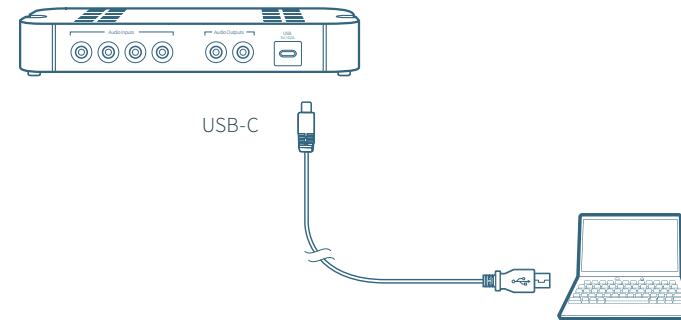

BACK

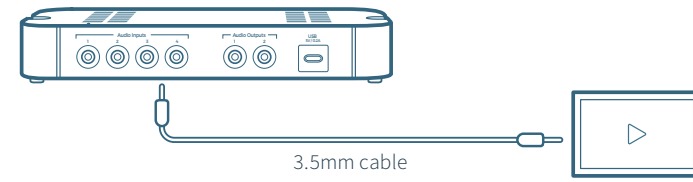

FRONT

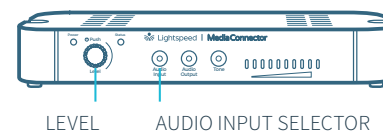



Audio Integration with Media Connector

The Media Connector is designed to integrate multiple audio sources quickly and easily.

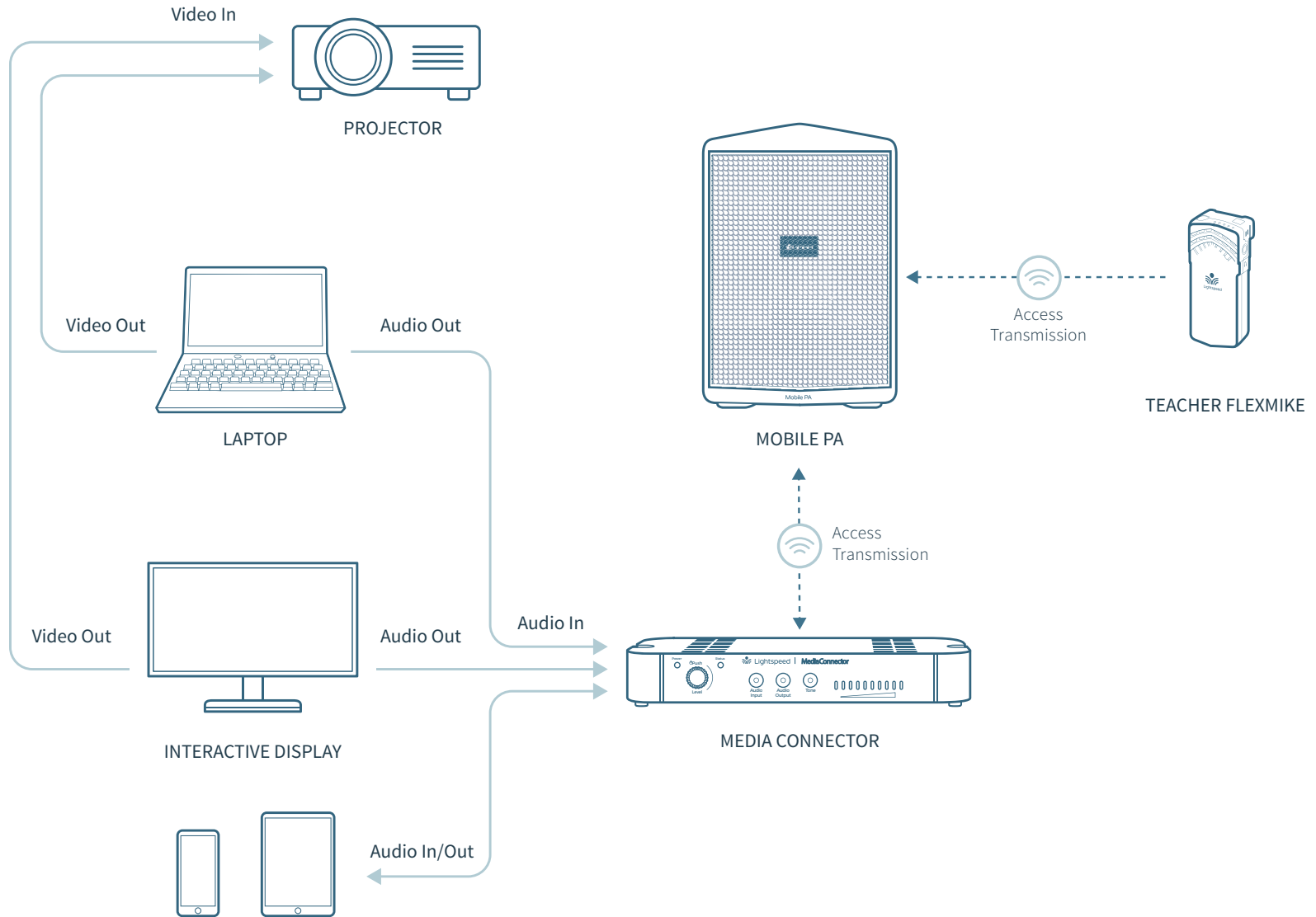



Pairing Mobile PA to Media Connector



Your system is shipped with microphones and base units pre-paired for quick and easy use. If you need to pair new components, follow this pairing process:

1

- Press and hold the Tone button on the Mobile PA for 3-5 seconds until the status light starts flashing blue/white, then release the button.
- At this point, the status light on Mobile PA will blink for 30 seconds.

2

- Press and hold the Tone selector button on the Media Connector for five seconds to put it into pairing mode. Once pairing is activated, the Status Light will begin flashing (blue/white).
- When the status lights are solid on both Mobile PA and Media Connector, pairing is successful.
- If after 30 seconds the status light blinks rapidly, you will need to start the pairing process again.
- Note: Pairing will fail if there is already an Mobile PA companion or another Media Connector paired and connected to the Mobile PA

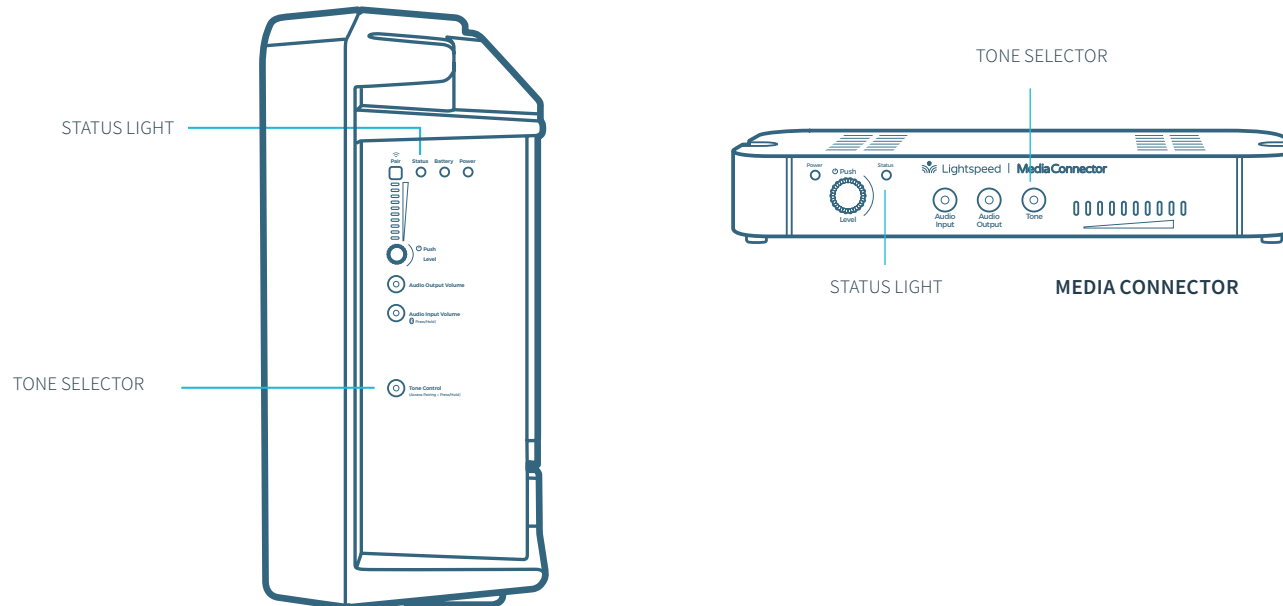



Connect Mobile PA to an Existing Audio System

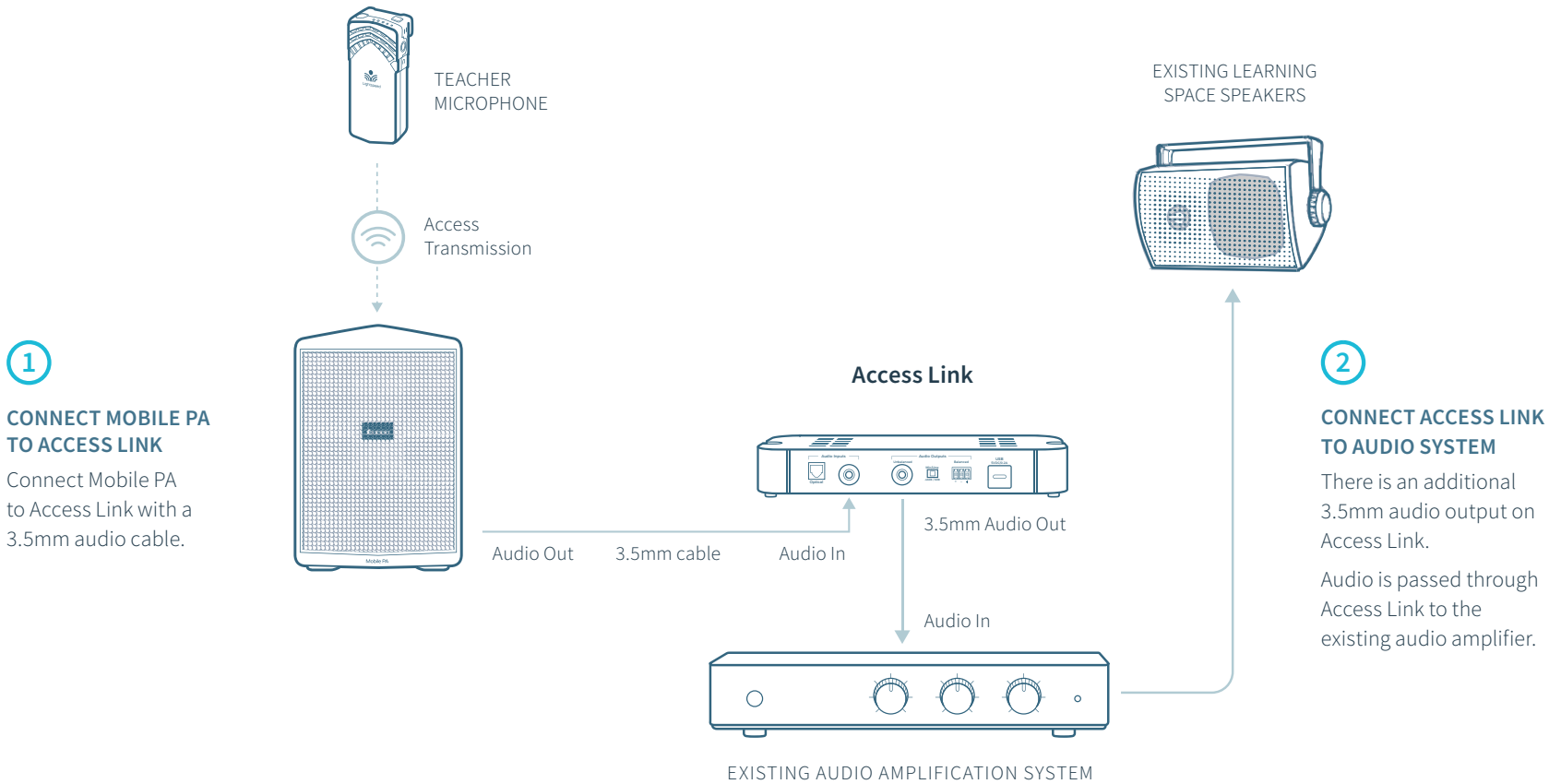



Adding Student Microphones to Mobile PA

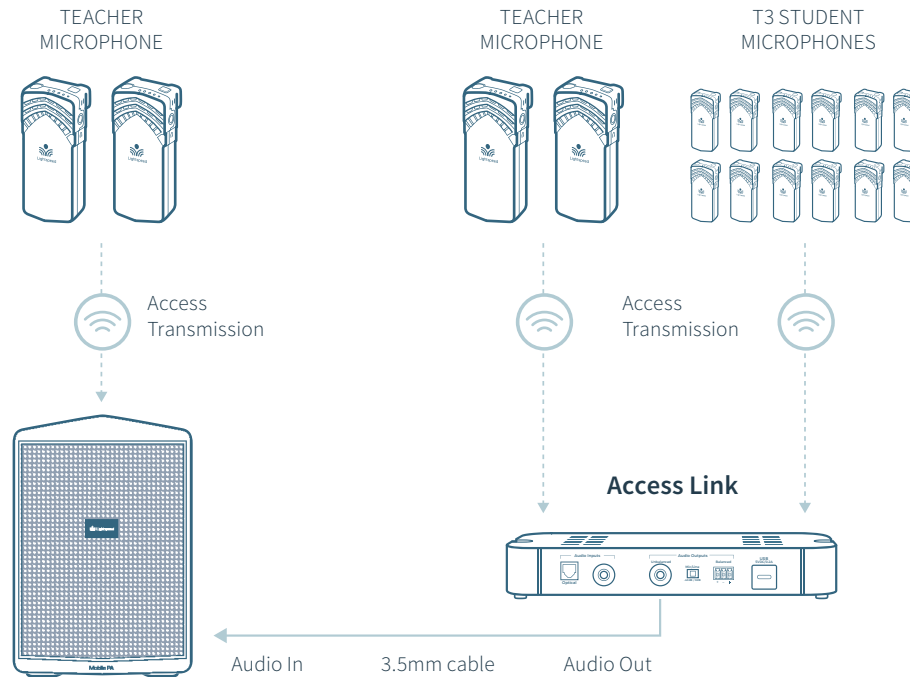

ADDITIONAL MICROPHONES

Add up to two extra teacher microphones and twelve T3 student microphones by connecting to an Access Link.

AUDIO OUTPUT

Access Link has one AUDIO OUTPUT which can be connected to the Audio Input on the Mobile PA using a 3.5mm cable. Audio from all microphones will be heard from the Mobile PA.



Output to Assistive Listening Device (ALD)

1. Turn the Audio Out volume control on Mobile PA side panel counterclockwise all way the down.
2. Determine the size and type of audio input jack on the device as many manufacturers' products differ in connector size and shape. Many personal FM transmitters require a 3.5mm to 3.5mm patch cable (part# MSC3535, not included).
3. Connect a patch cable from the ALD's microphone jack or AUX input to the 3.5mm audio jack labeled "Audio Out" on the side of Mobile PA.
4. With Mobile PA and ALD turned on, speak into the Flexmike and slowly adjust the Audio Out volume control until the appropriate audio level is attained in the ALD's receiver headphones.
5. It may be necessary to also adjust the volume on the Personal FM receiver to achieve appropriate volume level.

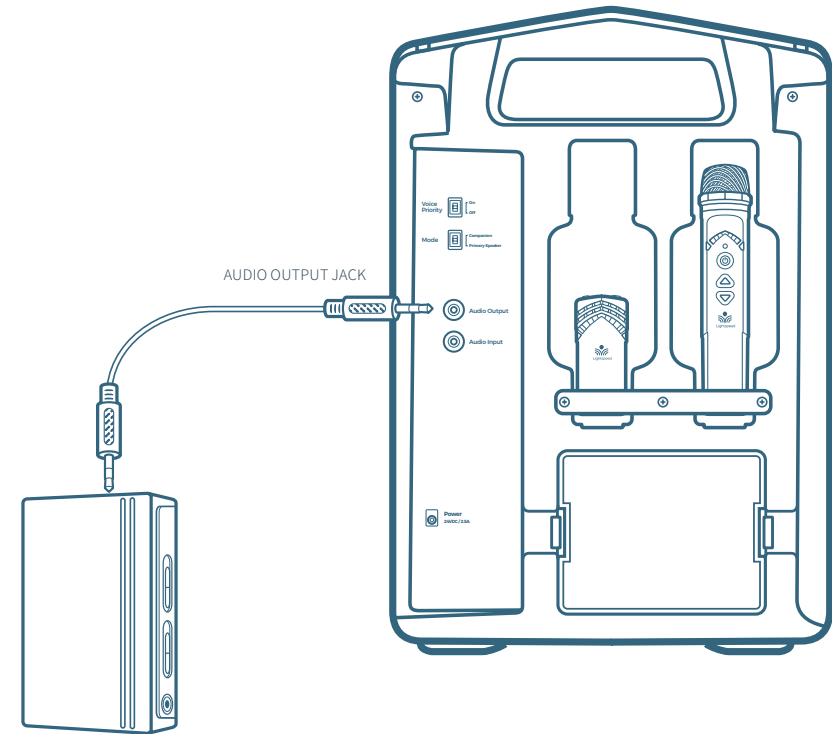



Using Your Microphone as a Wireless Audio Link

You can connect your 2nd (or 3rd) microphone to your computer's USB port to enable a wireless 2-way audio link.

SEND AUDIO FROM THE COMPUTER to Mobile PA to ensure all audio from the computer (videos, video conferencing, audio books, music, etc.) can be played.

SEND AUDIO TO THE COMPUTER from Mobile PA to ensure the teacher's Flexmike and any student microphones are clearly picked up by a video conferencing solution.

1. With a USB-C cable connect your microphone to your computer's USB port.
This will also power/charge your microphone.
2. Open sound settings on your computer:
 - Select Lightspeed Audio as the Output source to send all computer audio to Mobile PA.
 - Select Lightspeed Audio as the Input source to use the Lightspeed microphones as the computer microphone audio for video conferencing and recording applications.
3. You may also need to select Lightspeed Audio as the speaker and microphone audio in your video conferencing application the first time you use it.

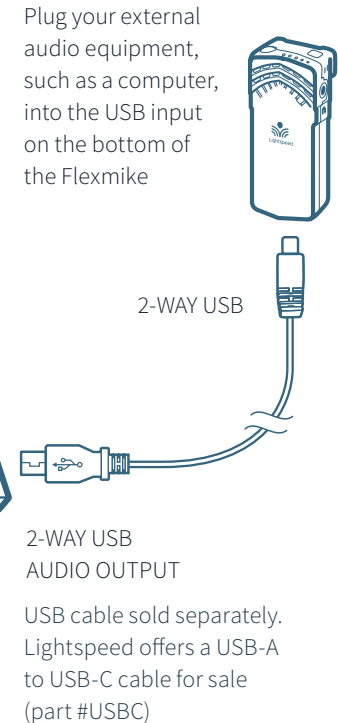
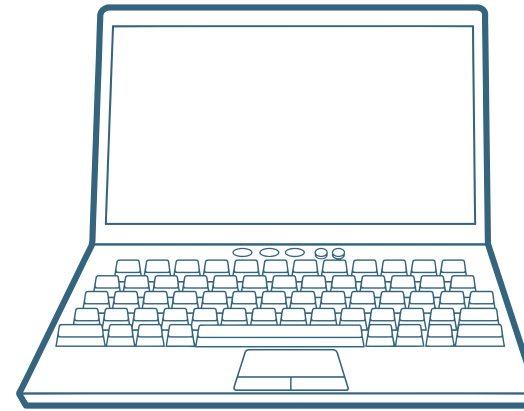

TIP: If your system includes two Flexmikes, you can use one mic for instructional audio and the second mic to send digital audio to and from another device .



MAINTENANCE & TROUBLESHOOTING

Microphone Battery Replacement

BATTERY PART # L3.7V

1. Push down on the latch and carefully pull the battery pack away from the microphone.
2. Insert new battery pack as shown and make sure the latch is secure.
3. Place the microphone in a cradle charger to charge the battery pack.

NOTE: Microphones will only charge when Mobile PA is plugged into AC power.

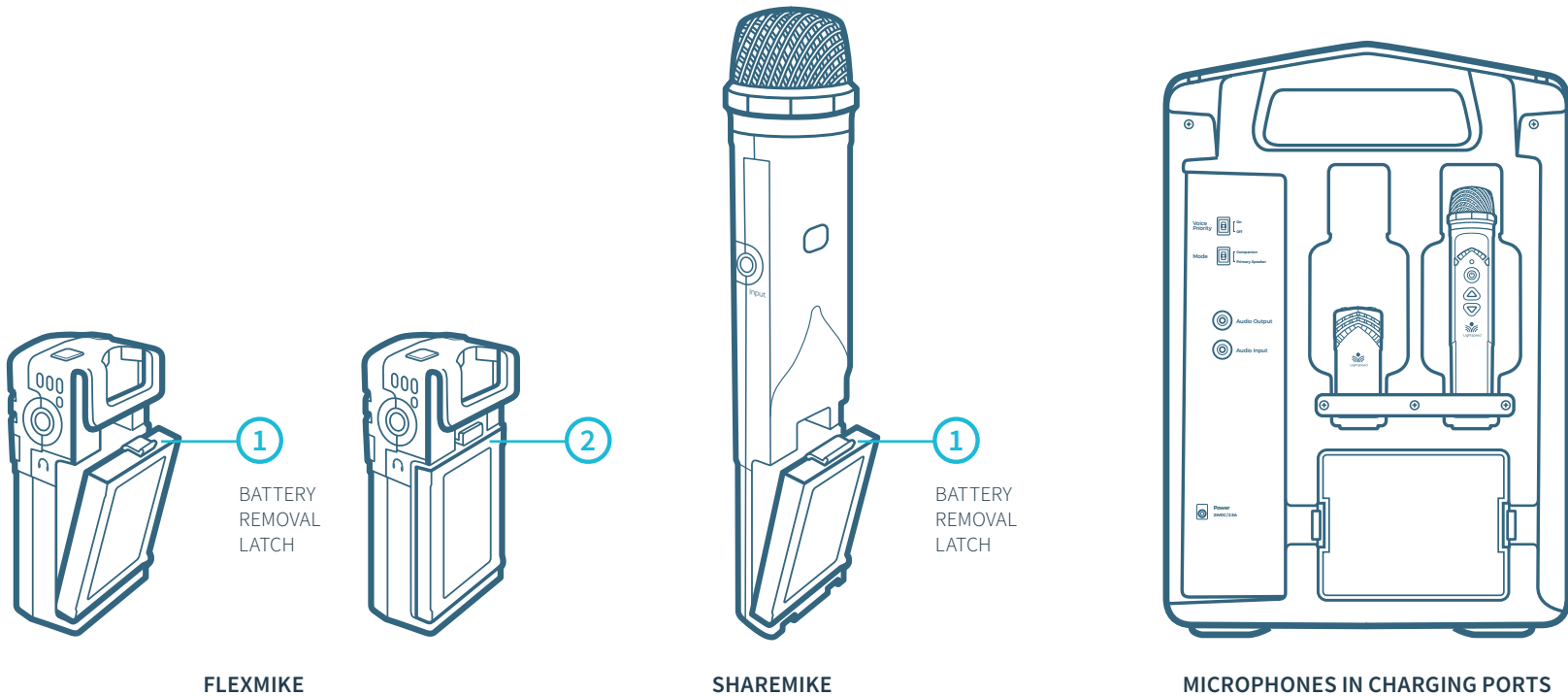



Battery Replacement

BATTERY PART # L14V

1. Find and remove the battery pack on the back of Mobile PA by pinching the tabs located on each side of the battery pack.
2. Place the new battery pack into the compartment by pinching the tabs on either side of the battery pack and inserting it into the compartment. Ensure that the connection on the battery pack matches up with the connection on the back of Mobile PA.
3. Ensure that the battery pack snaps into Mobile PA.
4. Press the power button on the Mobile PA to power it on when battery pack is inserted properly.

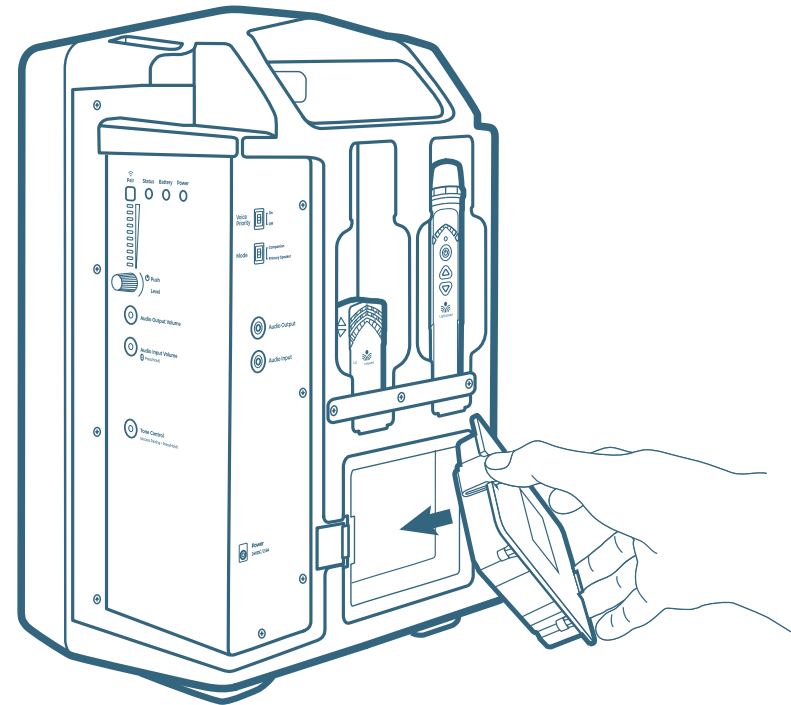



Troubleshooting

PROBLEM: Low battery indication: Most problems are directly related to low battery power. Please run through the “Battery Check” items first. For remaining troubleshooting, use known good, fully-charged batteries.

SOLUTION: Battery Check

- Confirm batteries are charged each night. A blinking red light on the battery status light indicates a low battery. Once Mobile PA is plugged into AC power, a solid red light on the battery status light will indicate charging.
- Confirm proper batteries are used: Flexmike and Sharemike require the Lightspeed #L3.7V rechargeable battery pack. The Mobile PA requires the Lightspeed #L14V rechargeable battery pack.
- Make sure the microphones obtain a full charge. A full charge takes 4-5 hours.
- When charging the microphones, the red charging light is solid. The green light will be solid when a full charge is reached.

PROBLEM: Low volume or feedback

SOLUTION: Follow these steps to eliminate low volume or feedback:

- If the volume is too high, feedback will occur. Adjust accordingly.
- Adjust the volume level on the Flexmike.
- Avoid standing directly in front of the Mobile PA as it will cause feedback.

PROBLEM: No sound from amplifier

SOLUTION: Follow these steps to produce sound from Mobile PA.

- Confirm that the white POWER light located on the side panel of Mobile PA is on.
- Confirm the microphone is powered on and linked to Mobile PA. The status light will be blue on Mobile PA indicating the microphone is linked.
- Confirm that microphone is not muted. A solid white light on the top of microphone will indicate it is muted. A solid blue light on the top of the microphone will indicate it is unmuted.
- Check volume level of Mobile PA. Volume level can be adjusted on the volume up/down buttons on the microphone. The volume can only be adjusted when the microphone is unmuted which is indicated by a blue power light.

PROBLEM: Software update is needed

SOLUTION: Follow these steps to update the software

- Go to <https://app.tara.lightspeed-tek.com/> and follow the steps.
- If you have a second Mobile PA, make sure to update the software in both the primary mode and companion mode. This is done by having your 1st speaker as the primary speaker paired to the 2nd as the companion speaker and then update the systems again with the 2nd speaker as the primary speaker paired to the 1st speaker that is paired as a companion speaker.



WARRANTY, SAFETY & SPECIFICATIONS

Five-Year Limited Warranty

Lightspeed Instructional Audio Systems are guaranteed against malfunction due to defects in materials and workmanship for a period of five (5) years, beginning at the date of the purchase invoice. If such malfunction occurs, the product will be repaired or replaced (at Lightspeed's option) without charge during the warranty period.

Lightspeed's Warranty Service Program applies to Mobile PA within its standard five (5) year warranty period.

1. Warranty on transceivers is five (5) years.
2. Warranty on Lightspeed NiMH and Lithium Polymer rechargeable batteries is one (1) year.
3. Warranty on microphones and components that support discontinued systems (FMA, SMA and FMCA) is one (1) year.
4. A prepaid shipping label will be provided by Lightspeed for warranty repairs within the United States. Customers outside the U.S. should refer to the Lightspeed website (www.lightspeed-tek.com) for warranty repair instructions.
5. Should Mobile PA system require service, the Mobile PA must first be shipped in for inspection and repair (at Lightspeed's expense). Once the system is inspected and if any/all issues are validated to be covered under warranty, the system will be repaired or replaced and shipped back to the customer at no charge.

6. Warranty does not extend to finish, appearance items, or malfunctions due to abuse or operation other than specified conditions, nor does it extend to incidental or consequential damages. Repair by other than Lightspeed or its authorized service agencies will void this warranty. Information on authorized service agencies is available from Lightspeed Technologies, Inc.
7. Lightspeed instructional audio products are not designed to be waterproof or water resistant and warranty does not extend to cover water damage due to weather or otherwise.

If you have questions, call Lightspeed Technical Services at 800.732.8999, 5am-5pm, PST.

Customers outside the U.S. should contact their local reseller.



Safety Warnings and Certifications



CAUTION

RISK OF ELECTRICAL SHOCK

DO NOT OPEN



THIS PRODUCT MUST BE INSTALLED IN ACCORDANCE WITH THE APPLICABLE INSTALLATION CODE BY A PERSON FAMILIAR WITH THE CONSTRUCTION AND OPERATION OF THE PRODUCT AND THE HAZARDS INVOLVED.



The lightning flash with arrowhead symbol inside an equilateral triangle is intended to alert the user to the presence of non insulated “hazardous voltage” within the product’s enclosure, which may be of sufficient magnitude to induce a risk of electric shock to persons.



The exclamation mark inside an equilateral triangle is intended to alert the user to the presence of important operating and maintenance (servicing) instruction in the literature accompanying this product.



USE A LIGHTSPEED SUPPLIED BATTERY ONLY



CAUTION: Risk of explosion if battery is replaced by an incorrect type. Dispose of used batteries according to the instructions.



Battery subjected to extremely low air pressure that may result in an explosion or the leakage of flammable liquid or gas.

CERTIFICATIONS



This product is listed to UL standards and requirements for electrical safety by Underwriters Laboratories Inc.



This product conforms with the essential requirements of the following European Union Directives: 2004/108/EC Electromagnetic Compatibility (EMC) and 2006/95/EC Low Voltage Directive (LVD).



LightSpeed Technologies launched a formal product recycle program in Europe that complies with the European Union Directive 2002/96/EC on Waste Electrical and Electronic Equipment (“WEEE Directive”). Please visit www.light-speed-tek.com for more information.



This product is manufactured using lead-free processes and is free of other materials harmful to the environment. It conforms to the most stringent new European guidelines for consumer products (RoHS).



Précautions De Sécurité et Certifications



ATTENTION
RISQUE D'ÉLECTROCUTION
NE PAS OUVRIR



CONFORMÉMENT AUX NORMES D'INSTALLATION APPLICABLES, CE PRODUIT DOIT ÊTRE INSTALLÉ PAR UNE PERSONNE FAMILIARISÉE AVEC LA CONCEPTION ET LE FONCTIONNEMENT DU PRODUIT ET CONSCIENTE DES RISQUE ENCOURUS.



L'éclair flèche dans un triangle équilatéral avertit l'utilisateur de la présence d'une "tension dangereuse" non isolée à l'intérieur de l'appareil, qui peut être d'une ampleur suffisante pour constituer un risque d'électrocution.



Le point d'exclamation contenu dans un triangle équilatéral avertit l'utilisateur de la présence d'importantes instructions d'exploitation et de maintenance dans la documentation qui accompagne ce produit.



UTILISEZ UNIQUEMENT LA BATTERIE LIGHTSPEED FOURNIE



ATTENTION: Risque d'explosion si la batterie est remplacée par un type incorrect. Mettre au rebut les batteries usagées selon les instructions.

CERTIFICATIONS



Ce produit est certifié conforme aux normes et aux exigences UL en matière de sécurité électrique par Underwriters Laboratories Inc.



Ce produit est conforme aux principales exigences des directives de l'Union Européenne suivantes : 2004/108/EC Electromagnetic Compatibility (EMC) and 2006/95/EC Low Voltage Directive (LVD).



Lightspeed Technologies a lancé un programme de recyclage de produits en Europe conformément à la directive de l'Union Européenne 2002/96/CE relative aux déchets d'équipements électriques et électroniques (directive « DEEE »). Veuillez visiter notre page Web www.Lightspeed-tek.com pour plus de renseignements.



Ce produit est fabriqué en utilisant des processus sans plomb ni aucune autre matière nuisible à l'environnement. Il est conforme aux nouvelles règles européennes les plus strictes en matière de biens de consommation (RoHS).



FCC Notice to User

This device complies with Part 15 of the FCC Rules. Operation is subject to the following two conditions:

1. This device may not cause harmful interference; and
2. This device must accept any interference received, including interference that may cause undesired operation.

This equipment has been tested and found to comply with the limits for a Class B digital device, pursuant to Part 15 of the FCC Rules. These limits are designed to provide reasonable protection against harmful interference in a residential installation.

This equipment generates, uses, and can radiate radio frequency energy and, if not installed and used in accordance with the instructions, may cause harmful interference to radio communications. However, there is no guarantee that interference will not occur in a particular installation.

If this equipment does cause harmful interference to radio or television reception, which can be determined by turning the equipment off and on, the user is encouraged to try to correct the interference by one or more of the following measures:

- Reorient or relocate the receiving antenna (that is, the antenna for radio or television that is receiving” the interference).
- Reorient or relocate and increase the separation between the telecommunications equipment and receiving antenna.
- Connect the telecommunications equipment into an outlet on a circuit different from that to which the receiving antenna is connected.
- Consult the dealer or an experienced radio/TV technician for help.

English:

IMPORTANT NOTE: To comply with the FCC RF exposure compliance requirements, the antenna(s) used for this transmitter must be installed to provide a separation distance of at least 20 cm from all persons and must not be co-located or operating in conjunction with any other antenna or transmitter. No change to the antenna or the device is permitted. Any change to the antenna or the device could result in the device exceeding the RF exposure requirements and void user’s authority to operate the device.

French:

NOTE IMPORTANTE: Pour se conformer aux règles d’exposition des ondes RF par la FCC, la (ou les) antenne(s) utilisée(s) par ce transmetteur doivent être installées de façon à être séparée d’une distance d’au moins 20 cm de toute personne et ne doit pas être utilisée près ou en conjonction avec aucune autre antenne ou transmetteur. Aucune modification à l’antenne ou à l’appareil n’est permise. Toute modification à l’antenne ou à l’appareil peut résulter que l’appareil excèdera l’exposition aux ondes RF réglementaires et ainsi annuler le droit à l’usager d’utiliser l’appareil.

FCC RF Radiation Exposure Statement

For body worn operation, the portable part (Flexmike) has been tested and meets FCC RF exposure guidelines.

This device must not be co-located or operating in conjunction with any other antenna or transmitter. The changes or modifications not expressly approved by the party responsible for compliance could void the user’s authority to operate the equipment.

Notice to Canada User

English

This device complies with Industry Canada licence exempt RSS standard(s).

Operation is subject to the following two conditions:

1. This device may not cause interference, and
2. This device must accept any interference, including interference that may cause undesired operation of the device.

French

Le présent appareil est conforme aux CNR d’Industrie Canada applicables aux appareils radio exempts de licence. L’exploitation est autorisée aux deux conditions suivantes:

1. L’appareil ne doit pas produire de brouillage, et
2. L’utilisateur de l’appareil doit accepter tout brouillage radioélectrique subi, même si le brouillage est susceptible d’en compromettre le fonctionnement



Notice for Universal Serial Bus (USB)

RF Radiation Exposure Statement

English

Your mobile device is a radio transmitter and receiver. It is designed not to exceed the limits for exposure to radio waves (radio frequency electromagnetic fields) recommended by international guidelines. The guidelines were developed by Health Canada and include a substantial safety margin designed to assure the safety of all persons, regardless of age and health.

French

Votre appareil mobile est un émetteur-récepteur radio. Il est conçu pour ne pas dépasser les limites d'exposition aux ondes radio (champs électromagnétiques de fréquence radio) recommandées par les directives internationales. Les lignes directrices ont été élaborées par Santé Canada et comprennent une marge de sécurité importante destinée à assurer la sécurité de toutes les personnes, indépendamment de l'âge et de la santé.

NOTE: Lightspeed is not responsible for any changes or modifications not expressly approved by the party responsible for compliance. Such modifications could void the user's authority to operate the equipment.

NOTE: This equipment has been tested and found to comply with the limits for a Class B digital device, pursuant to part 15 of the FCC Rules. These limits are designed to provide reasonable protection against harmful interference in a residential installation. This equipment generates, uses and can radiate radio frequency energy and, if not installed and used in accordance with the instructions, may cause harmful interference to radio communications. However, there is no guarantee that interference will not occur in a particular installation. If this equipment does cause harmful interference to radio or television reception, which can be determined by turning the equipment off and on, the user is encouraged to try to correct the interference by one or more of the following measures:

- Reorient or relocate the receiving antenna.
- Increase the separation between the equipment and receiver.
- Connect the equipment into an outlet on a circuit different from that to which the receiver is connected.
- Consult the dealer or an experienced radio/TV technician for help.



Canada, Industry Canada (IC) Notices

English

This device complies with Industry Canada license exempt RSS standard(s). This Class B digital apparatus complies with Canadian ICES-003 and CAN ICES-3(B)/NMB-3(B). Operation is subject to the following two conditions: (1) this device may not cause interference, and (2) this device must accept any interference, including interference that may cause undesired operation of the device. The IC for this device is IC ID 1732B-LSRCN. This includes accessories such as the Flexmike (IC 1732B-LSFMN), Sharemike (IC 1732B-LSSMN) and Media Connector (IC 1732B-LSMCN).

French

Canada, avis d'Industrie Canada (IC)

Cet appareil numérique de classe B est conforme aux normes canadiennes ICES-003 et RSS-247. Son fonctionnement est soumis aux deux conditions suivantes: (1) cet appareil ne doit pas causer d'interférence et (2) cet appareil doit accepter toute interférence, notamment les interférences qui peuvent affecter son fonctionnement. L'identifiant IC de cet appareil est IC ID 1732B-LSRCN. Ceci inclus les accessoires comme le Flexmike (IC 1732B-LSFMN), Sharemike (IC 1732B-LSSMN) et un Media Connector (IC 1732B-LSMCN).

Cet équipement est conforme aux limites d'exposition aux radiations IC inaux doivent suivre les instructions d'utilisation spécifiques pour satisfaire la conformité à l'exposition IC, veuillez suivre les instructions de fonctionnement décrites dans ce manuel.



EU Declaration of Conformity

According to EU Directives EMC 2014/30/EU, LVD 2014/35/EU, RED 2014/53/EU, RoHS 2011/65/EU

Manufacturer: Lightspeed Technologies, Inc.
Address: 11509 SW Herman Rd.
Tualatin, Oregon 97062

We herewith declare that the following systems comply with the appropriate basic safety and health requirements of the Directive based on its design and type, as brought into circulation by us. In case of alteration of the system, not agreed upon by us, this declaration will lose its validity.

Products: Redcat, Topcat, 975, Access Link, Flexmike, Sharemike, Pod, Activate Station, Media Connector, Mobile PA

Model Numbers: RCN, TCN, 975, ALN, FMN, SMN, POD, ACT, MCN, MPA

As applicable, products conform to the standards listed below:

EN 62368-1:2014
IEC 62133:2012
EN 50385:2017
EN 50566:2017
EN 50663:2017
EN 62479:2010
ETSI EN 301 406 V2.2.2 (2016-09)
ETSI EN 301 489-1 V2.2.3 (2019-11)
ETSI EN 301 489-6 V2.2.1 (2019-04)
EN IEC 63000:2018

The Technical Construction File is available to proper authorities and the product is CE marked.

Lightspeed Representative

Date: December 6, 2022

Michael Frost, Compliance Engineer



System Components

STANDARD COMPONENTS

MPA	Wireless audio base station
24V-2.5A-NA	24V/2.5A power supply for MPA
FMN	Flexmike classroom transceiver with battery pack and lanyard
SMN	Sharemike handheld transceiver with battery pack
EMA	Earset microphone with TRRS connector for Flexmike
L3.7V	Lithium Polymer rechargeable battery pack for microphone, one per microphone
L14V	Lithium Polymer rechargeable battery for Mobile PA
FL	Flexmike lavalier cord
STP	Mobile PA carry strap

STANDARD COMPONENTS (outside U.S. and Canada)

MPAG	Wireless audio base station
24V-2.5A	24V/2.5A power supply for MPA, specify country
FMNG	Flexmike classroom transceiver with battery pack and lanyard
SMNG	Sharemike handheld transceiver with battery pack
EMA	Earset microphone with TRRS connector for Flexmike
L3.7V	Lithium Polymer rechargeable battery pack for microphone, one per microphone
L14V	Lithium Polymer rechargeable battery for Mobile PA
FL	Flexmike lavalier cord
STP	Mobile PA carry strap

OPTIONAL ACCESSORIES

TPOD	Mobile PA tripod
MCN	Media Connector with Access Technology, power adaptor and power cord



System Specifications

MPA

Description	Mobile Portable Audio System
Frequency response	120 Hz - 13 kHz (-10dB)
DC power input	24V/2.5A
Power output	40 Watts RMS
Wireless communication	Access Technology (1.9 GHz)
Tone control	1 bass/treble control
Audio inputs	One 3.5mm stereo with volume control
Audio output	One 3.5mm stereo with volume control
Audio Link indicators	1 indicator to show link to microphone
Device registration	IR receiver to start pairing process with Flexmike(s), Sharemike(s), and Media Connector
Dimensions (W x H x D)	10.5" x 7.5" x 16" (267 x 191 x 406mm)
Weight with battery	10 lbs

FLEXMIKE (1-2)

Description	Pendant-style transceiver
Wireless communication	Access Technology (1.9 GHz)
Audio distortion	<1%
Integrated microphone	Uni-directional electret
Earbud output	3.5mm
Audio input	USB-C
Volume control	+/- 6 dB
Battery power	3.7V LiPo battery pack
Battery life	8 hours (fully charged)
Charging	2 contacts for cradle charging
USB connection	Type C for charging and audio
Power	On/off button
Registration	Push button for registration with Access Link
Dimensions (L x W x H)	2.9" x 1.1" x 0.7" (74 x 28 x 18mm)
Weight	1.2 oz (34g)

SHAREMIKE (1-2)

Description	Handheld transceiver
Wireless communication	Access Technology (1.9 GHz)
Audio distortion	<1%
Integrated microphone	Uni-directional electret
Audio input	3.5mm
Battery power	3.7V LiPo battery pack
Battery life	8 hours (fully charged)
Charging	2 contacts for cradle charging
Power	On/off button
Registration	Push button for registration with Access Link
Dimensions (L x W x H)	6.0" x 1.1" x 1.1" (153 x 28 x 28mm)
Weight	2.6 oz (73g)

MEDIA CONNECTOR

Description	Wireless audio transceiver
USB power	5V USB-C connector
Wireless communication	Access Technology (1.9 GHz)
Tone control	1 bass/treble control
Audio input	3.5mm stereo (x4) with master volume
Audio output	3.5mm stereo (x2) mixed with volume control
Audio Link indicator	1 LED on front panel
Device registration	Push button for Access Link
Dimensions (W x H x D)	7.6" x 5" x 1.13" (193 x 127 x 29mm)
Weight	9.6 oz. (272g)



Dedicated to Access for All

We strive to make a remarkable difference for teachers and students by creating Access to powerful in-the-moment insights to the learning process. Our audio and video solutions improve student engagement, enable teachers to activate small groups, and encourage collaboration.

11509 SW HERMAN ROAD
TUALATIN, OREGON 97062
TOLL FREE: 800.732.8999
PHONE: 503.684.5538
FAX: 503.684.3197
LIGHTSPEED-TEK.COM